

Constraint Satisfaction

Russell & Norvig Ch. 6

Overview

- Constraint satisfaction is a powerful problem-solving paradigm
 - Problem: **set of variables** to which we must assign **values** satisfying **problem-specific constraints**
 - Constraint programming, constraint satisfaction problems (CSPs), constraint logic programming...
- Algorithms for CSPs
 - Backtracking (systematic search)
 - Constraint propagation (k-consistency)
 - Variable and value ordering heuristics
 - Backjumping and dependency-directed backtracking

Motivating example: 8 Queens

Place 8 queens on a chess board such
That none is attacking another.

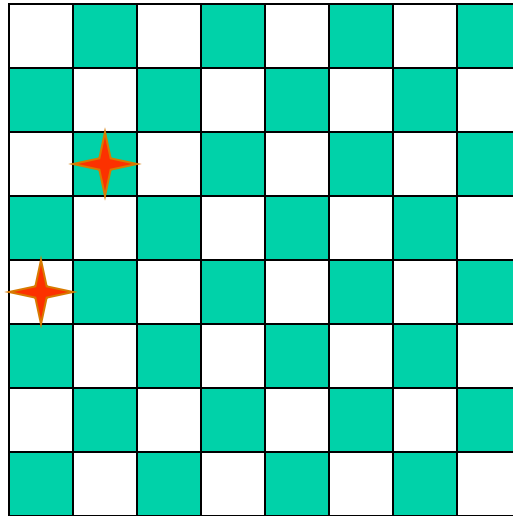

Generate-and-test, with no
redundancies → “only” 8^8 combinations

*$8^{**}8$ is 16,777,216*

Motivating example: 8-Queens

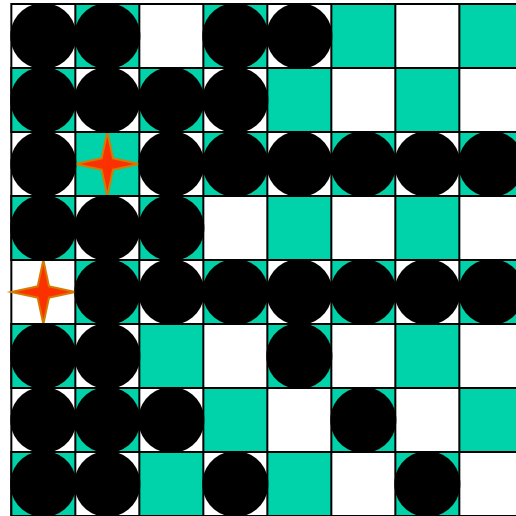

After placing these two queens, it's trivial to make the squares we can no longer use

What more do we need for 8 queens?

- Not just a *successor function* and *goal test*
 - But also
 - a means to *propagate constraints* imposed by one queen on the others
 - an *early failure test*
- Explicit representation of constraints and constraint manipulation algorithms

Informal definition of CSP

- CSP = Constraint Satisfaction Problem, given
 - (1) finite set of variables
 - (2) each with domain of possible values (often finite)
 - (3) set of constraints limiting values variables can take on
- **Solution** is an assignment of a value to each variable such that the constraints are all satisfied
- Tasks might be to decide if a solution exists, to find a solution, to find all solutions, or to find “best solution” according to some metric (objective function).

Example: 8-Queens Problem

- Eight variables X_i , $i = 1..8$ where X_i is the row number of queen in column i
- Domain for each variable $\{1,2,\dots,8\}$
- Constraints are of the forms:
 - Not on same row:
 $X_i = k \rightarrow X_j \neq k$ for $j = 1..8, j \neq i$
 - Not on same diagonal
 $X_i = k_i, X_j = k_j \rightarrow |i-j| \neq |k_i - k_j|$ for $j = 1..8, j \neq i$

Example: Task Scheduling

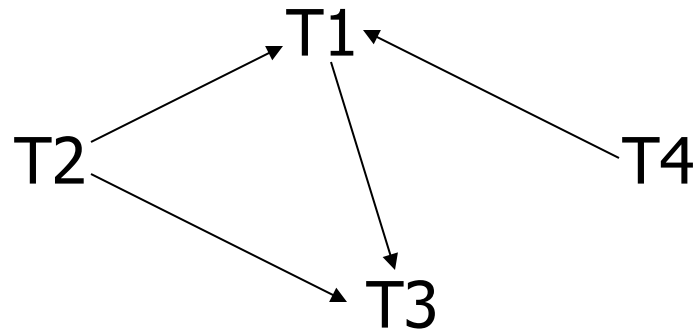

Examples of scheduling constraints:

- T1 must be done during T3
- T2 must be achieved before T1 starts
- T2 must overlap with T3
- T4 must start after T1 is complete

Example: Map coloring

Color the following map using three colors (red, green, blue) such that no two adjacent regions have the same color.

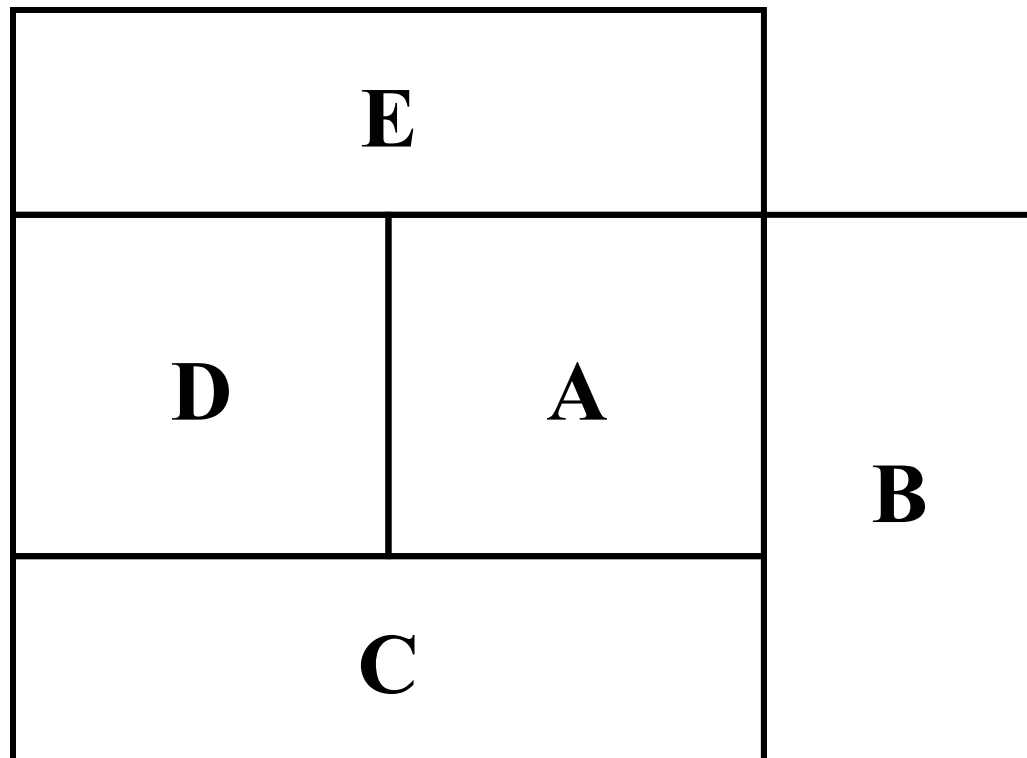

Map coloring

- Variables: A, B, C, D, E all of domain RGB
- Domains: RGB = {red, green, blue}
- Constraints: $A \neq B$, $A \neq C$, $A \neq E$, $A \neq D$, $B \neq C$, $C \neq D$, $D \neq E$
- A solution: A=red, B=green, C=blue, D=green, E=blue

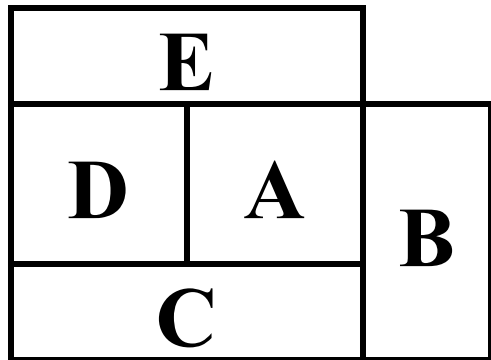

\Rightarrow

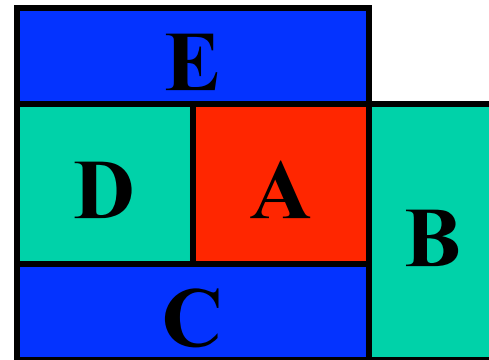

Brute Force methods

- Finding a solution by a brute force search is easy
 - **Generate and test** is a weak method
 - Just generate potential combinations and test each
- Potentially very inefficient
 - With n variables where each can have one of 3 values, there are 3^n possible solutions to check
- There are ~ 190 countries in the world, which we can color using four colors
- 4^{190} is a big number!

```
solve(A,B,C,D,E) :-  
    color(A),  
    color(B),  
    color(C),  
    color(D),  
    color(E),  
    not(A=B),  
    not(A=B),  
    not(B=C),  
    not(A=C),  
    not(C=D),  
    not(A=E),  
    not(C=D).
```

```
color(red).  
color(green).  
color(blue).
```

Example: SATisfiability

- Given a set of propositions containing variables, find an assignment of the variables to {false, true} that satisfies them.
- For example, the clauses:
 - $(A \vee B \vee \neg C) \wedge (\neg A \vee D)$
 - (equivalent to $(C \rightarrow A) \vee (B \wedge D \rightarrow A)$)are satisfied by
 - A = false, B = true, C = false, D = false
- Satisfiability is known to be NP-complete, so in the worst case, solving CSP problems requires exponential time

Real-world problems

CSPs are a good match for many practical problems that arise in the real world

- Scheduling
- Temporal reasoning
- Building design
- Planning
- Optimization/satisfaction
- Vision
- Graph layout
- Network management
- Natural language processing
- Molecular biology / genomics
- VLSI design

Definition of a constraint network (CN)

A constraint network (CN) consists of

- a set of **variables** $X = \{x_1, x_2, \dots, x_n\}$
 - each with associated domain of values $\{d_1, d_2, \dots, d_n\}$
 - domains are typically finite
- a set of **constraints** $\{c_1, c_2, \dots, c_m\}$ where
 - each defines a predicate which is a relation over a particular subset of variables (X)
 - e.g., C_i involves variables $\{X_{i1}, X_{i2}, \dots, X_{ik}\}$ and defines the relation $R_i \subseteq D_{i1} \times D_{i2} \times \dots \times D_{ik}$

Running example: coloring Australia

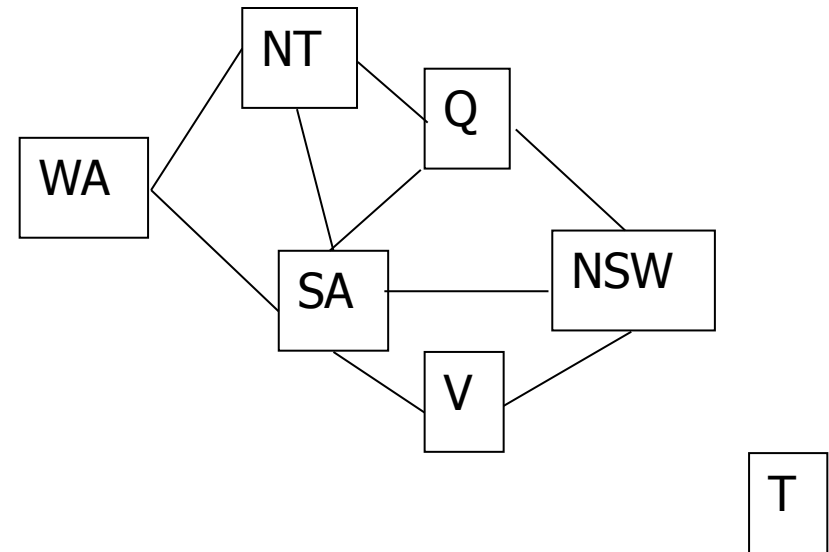

- Seven variables: $\{\mathbf{WA, NT, SA, Q, NSW, V, T}\}$
- Each variable has the same domain: $\{\mathbf{red, green, blue}\}$
- No two adjacent variables have the same value:
 $\mathbf{WA \neq NT, WA \neq SA, NT \neq SA, NT \neq Q, SA \neq Q, SA \neq NSW, SA \neq V, Q \neq NSW, NSW \neq V}$

Unary & binary constraints most common

Binary constraints

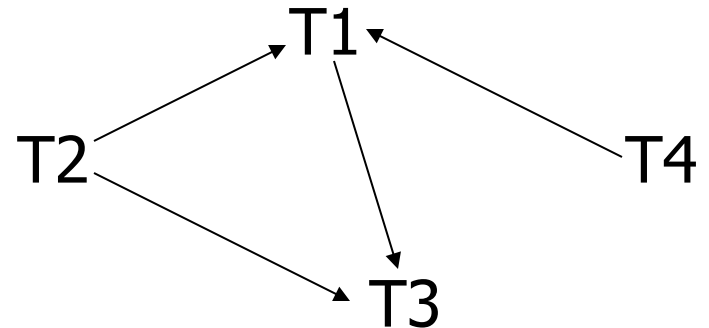
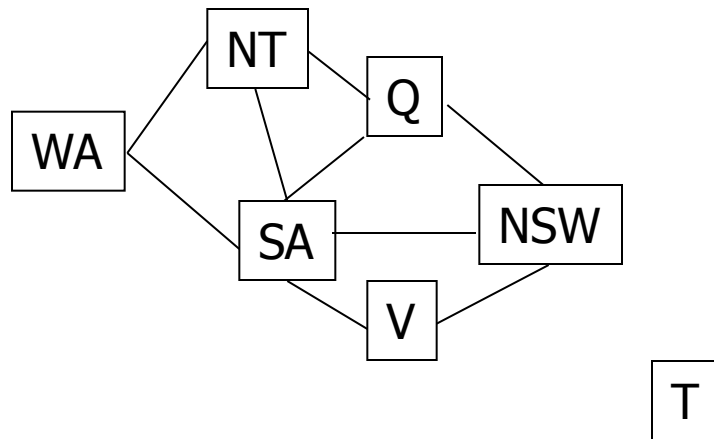

- Two variables are adjacent or neighbors if connected by an edge or an arc
- Possible to rewrite problems with higher-order constraints as ones with just binary constraints
 - Reification

Formal definition of a CN

- Instantiations
 - An **instantiation** of a subset of variables S is an assignment of a value in its domain to each variable in S
 - An instantiation is **legal** iff it does not violate any constraints
- A **solution** is an instantiation of all of the variables in the network

Typical tasks for CSP

- Solution related tasks:
 - Does a solution *exist*?
 - Find *one* solution
 - Find *all* solutions
 - Given a metric on solutions, find the *best* one
 - Given a partial instantiation, do any of the above
- Transform the CN into an equivalent CN that is easier to solve

Binary CSP

- A **binary CSP** is a CSP where all constraints are binary or unary
- Any non-binary CSP can be converted into a binary CSP by introducing additional variables
- A binary CSP can be represented as a **constraint graph**, with a node for each variable and an arc between two nodes iff there's a constraint involving the two variables
 - Unary constraints appear as self-referential arcs

Running example: coloring Australia

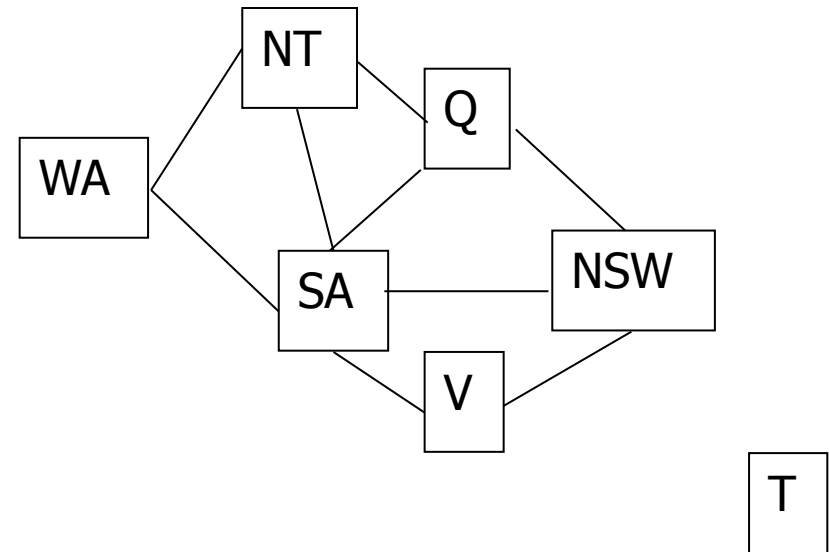

- Seven variables: $\{\mathbf{WA, NT, SA, Q, NSW, V, T}\}$
- Each variable has the same domain: $\{\mathbf{red, green, blue}\}$
- No two adjacent variables have the same value:
 $\mathbf{WA \neq NT, WA \neq SA, NT \neq SA, NT \neq Q, SA \neq Q, SA \neq NSW, SA \neq V, Q \neq NSW, NSW \neq V}$

A running example: coloring Australia

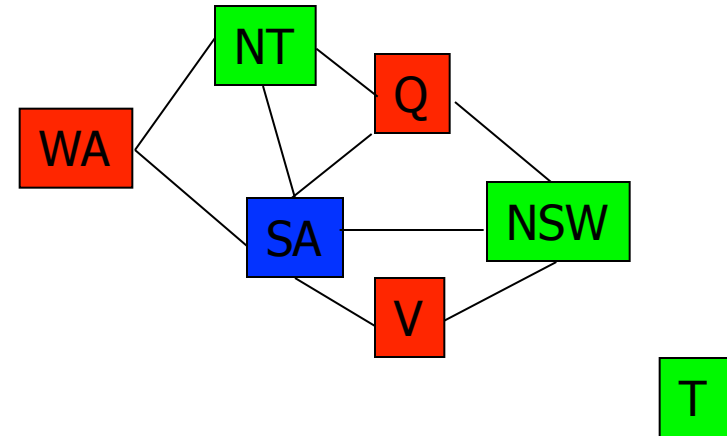
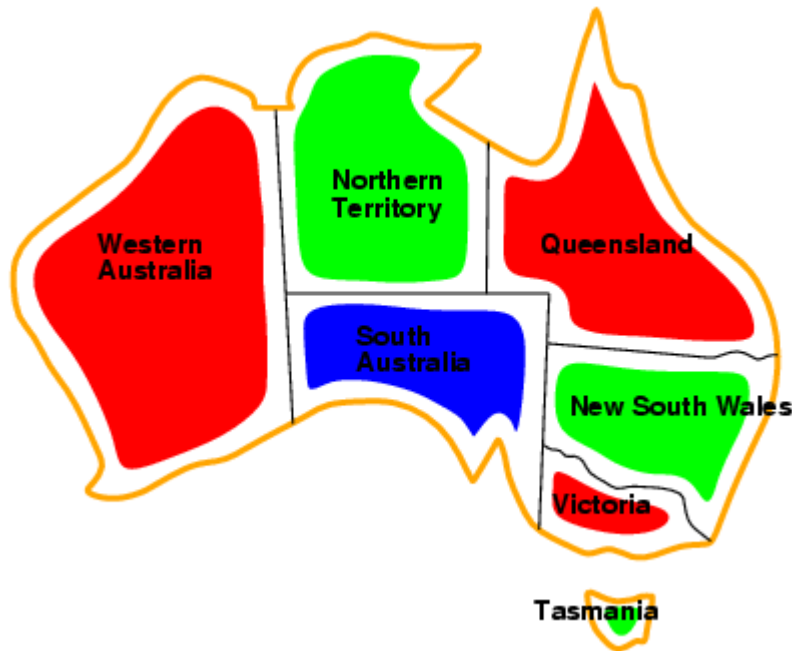

- Solutions are complete and consistent assignments
- One of several solutions
- Note that for generality, constraints can be expressed as relations, e.g., $WA \neq NT$ is
(WA,NT) in {(red,green), (red,blue), (green,red), (green,blue), (blue,red),(blue,green)}

Backtracking example



Backtracking example



Backtracking example

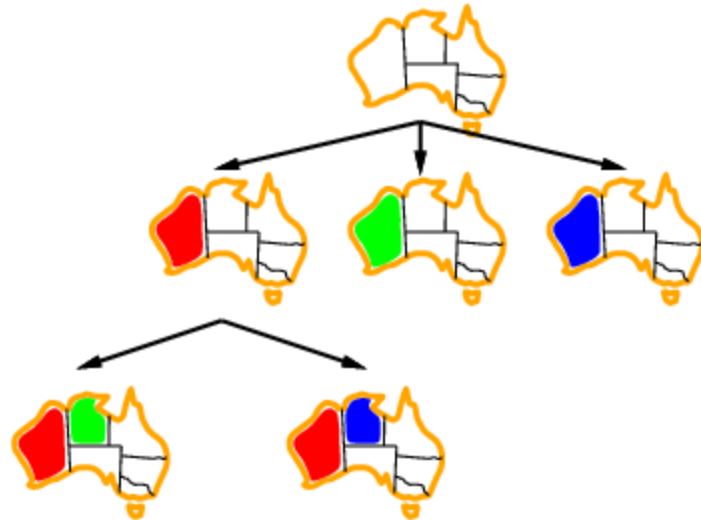

Backtracking example

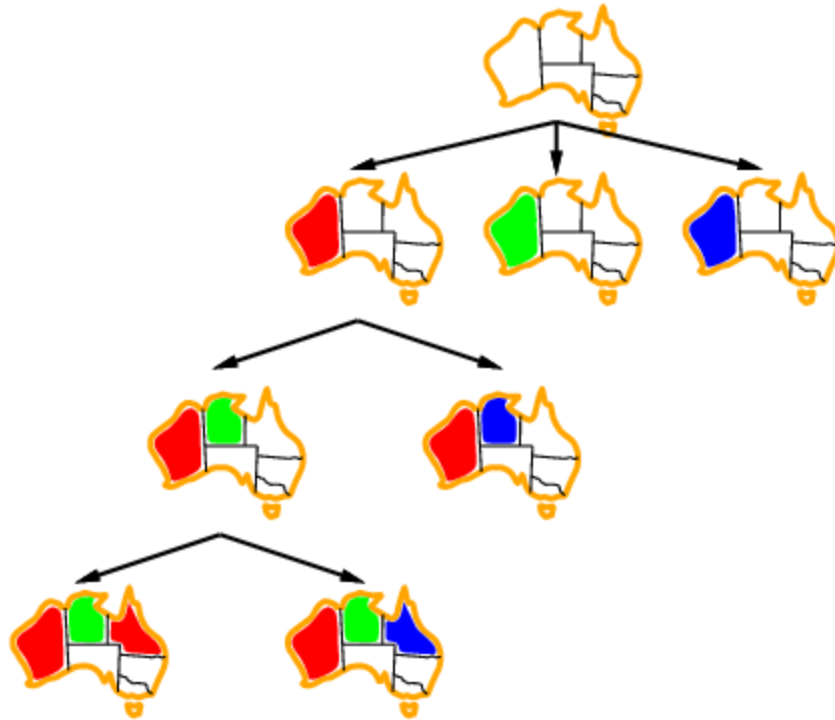

Basic Backtracking Algorithm

CSP-BACKTRACKING(PartialAssignment a)

- If a is complete then return a
- $X \leftarrow$ select an unassigned variable
- $D \leftarrow$ select an ordering for the domain of X
- For each value v in D do
 - If v is consistent with a then
 - Add (X= v) to a
 - result \leftarrow CSP-BACKTRACKING(a)
 - If result \neq *failure* then return result
 - Remove (X= v) from a
- Return *failure*

Start with CSP-BACKTRACKING({})

Note: this is depth first search; can solve n-queens problems for $n \sim 25$

Problems with backtracking

- Thrashing: keep repeating the same failed variable assignments
- Things that can help avoid this:
 - Consistency checking
 - Intelligent backtracking schemes
- Inefficiency: can explore areas of the search space that aren't likely to succeed
 - Variable ordering can help

Improving backtracking efficiency

Here are some standard techniques to improve the efficiency of backtracking

- Can we detect inevitable failure early?
- Which variable should be assigned next?
- In what order should its values be tried?

Forward Checking

After a variable X is assigned a value v , look at each unassigned variable Y connected to X by a constraint and delete from Y 's domain values inconsistent with v

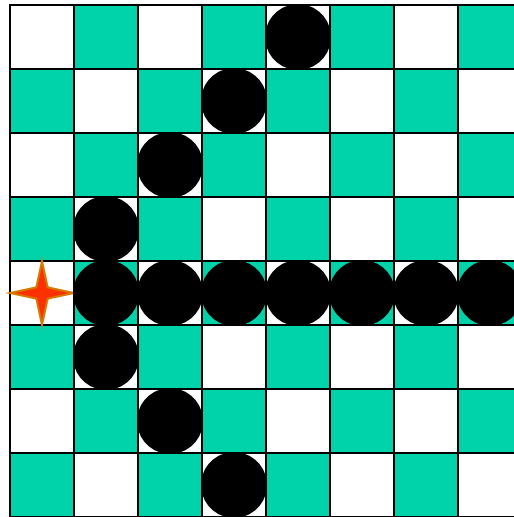

Using *forward checking* and *backward checking* roughly doubles the size of N-queens problems that can be practically solved

Forward checking



- Keep track of remaining legal values for unassigned variables
- Terminate search when any variable has no legal values

Forward checking

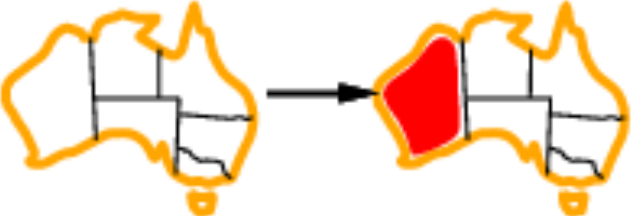

WA

NT

Q

NSW

V

SA

T



Forward checking



WA	NT	Q	NSW	V	SA	T
  	  	  	  	  	  	  
	 	  	  	  	 	  
			 	  		  

Forward checking

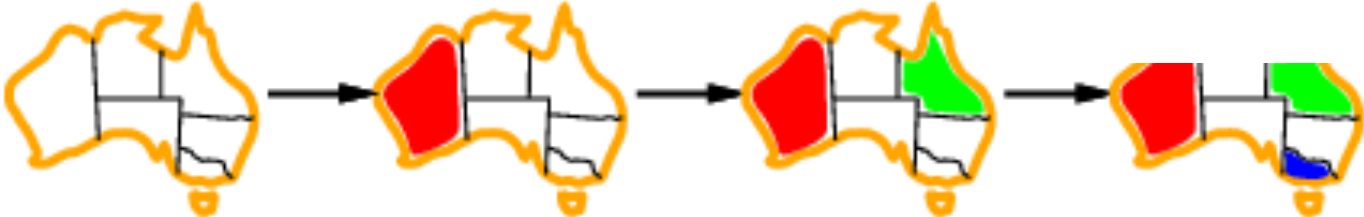

WA NT Q NSW V SA T

■	■	■	■	■	■	■
■		■	■	■		■
■			■	■		■
■		■	■			■

Constraint propagation

- Forward checking propagates info. from assigned to unassigned variables, but doesn't provide early detection for all failures
- NT and SA cannot both be blue!



WA

NT

Q

NSW

V

SA

T

Definition: Arc consistency

- A constraint C_{xy} is *arc consistent* wrt x if for each value v of x there is an allowed value of y
- Similarly define C_{xy} as arc consistent wrt y
- A binary CSP is arc consistent iff every constraint C_{xy} is arc consistent wrt x as well as y
- When a CSP is not arc consistent, we can make it arc consistent, e.g., by using AC3
 - This is also called “enforcing arc consistency”

Arc Consistency Example

- **Domains**

- $D_x = \{1, 2, 3\}$

- $D_y = \{3, 4, 5, 6\}$

- **Constraint**

- $C_{xy} = \{(1,3), (1,5), (3,3), (3,6)\}$

- C_{xy} is not arc consistent wrt x , neither wrt y . By enforcing arc consistency, we get reduced domains

- $D'_x = \{1, 3\}$

- $D'_y = \{3, 5, 6\}$

Arc consistency



- Simplest form of propagation makes each arc consistent
- $X \rightarrow Y$ is consistent iff for every value x of X there is some allowed y

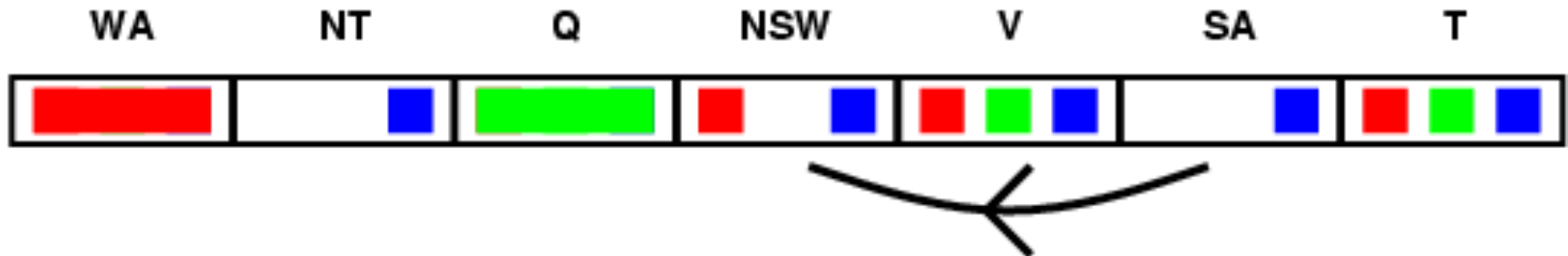

Arc consistency



- Simplest form of propagation makes each arc consistent
- $X \rightarrow Y$ is consistent iff for every value x of X there is some allowed y

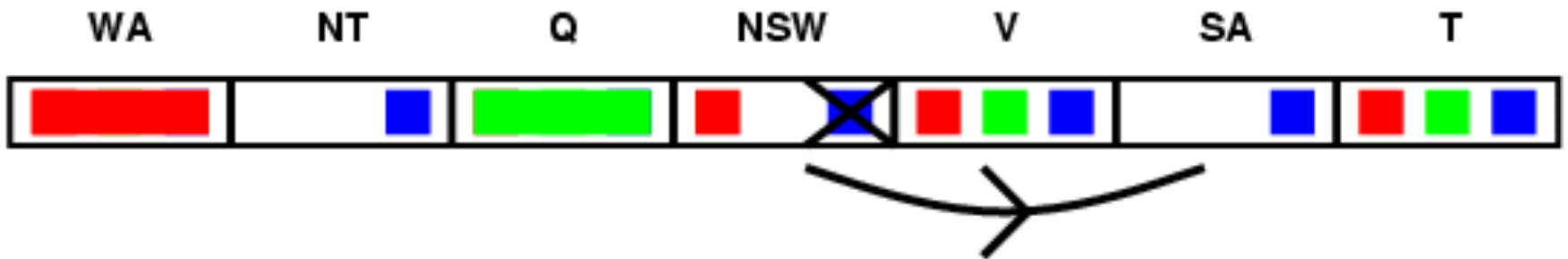

Arc consistency

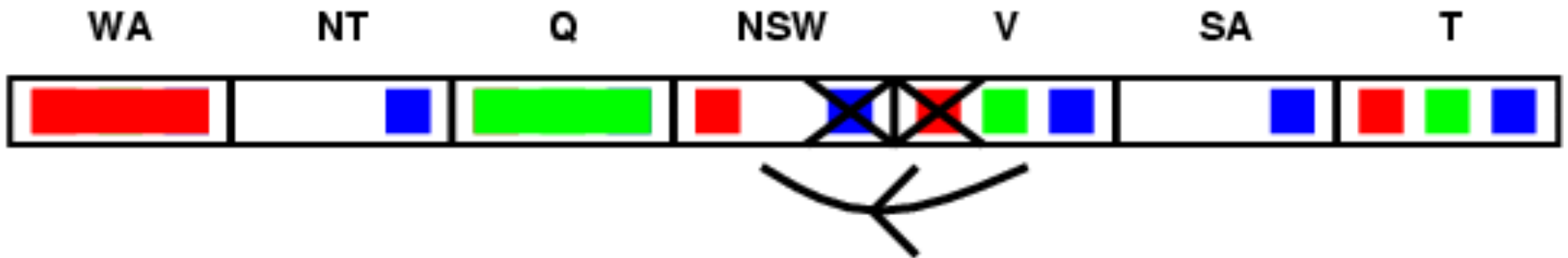

If X loses a value, neighbors of X need to be rechecked

Arc consistency

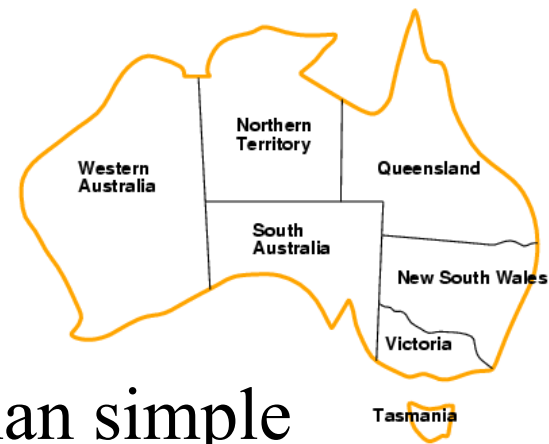

- Arc consistency detects failure earlier than simple forward checking
- Can be run as a preprocessor or after each assignment

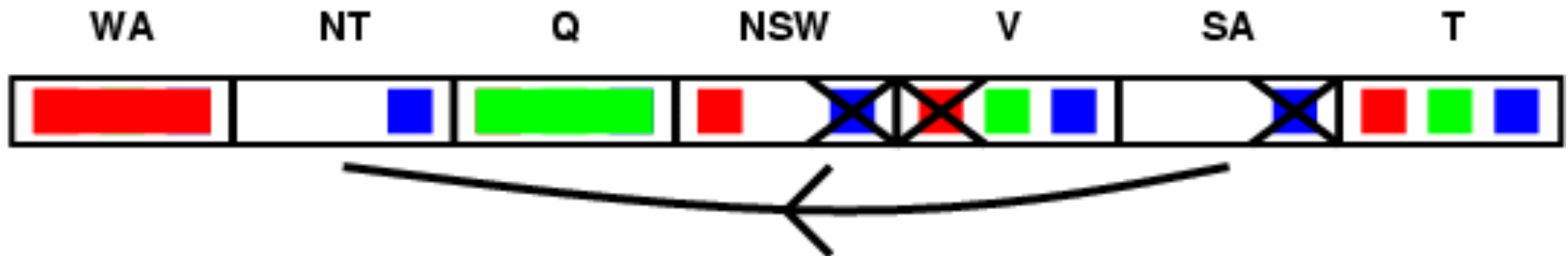

General CP for Binary Constraints

Algorithm [AC3](#)

contradiction \leftarrow *false*

Q \leftarrow stack of all variables

while Q is not empty and not contradiction do

 X \leftarrow UNSTACK(Q)

 For every variable Y adjacent to X do

 If REMOVE-ARC-INCONSISTENCIES(X,Y)

 If domain(Y) is non-empty then STACK(Y,Q)

 else return false

Complexity of AC3

- e = number of constraints (edges)
- d = number of values per variable
- Each variable is inserted in Q up to d times
- REMOVE-ARC-INCONSISTENCY takes $O(d^2)$ time
- CP takes $O(ed^3)$ time

Improving backtracking efficiency

- Here are some standard techniques to improve the efficiency of backtracking
 - Can we detect inevitable failure early?
 - Which variable should be assigned next?
 - In what order should its values be tried?
- Combining constraint propagation with these heuristics makes 1000 N-queen puzzles feasible

Most constrained variable



- Most constrained variable:
choose the variable with the fewest legal values



- a.k.a. **minimum remaining values (MRV)**
heuristic
- After assigning a value to WA, NT and SA have only two values in their domains – choose one of them rather than Q, NSW, V or T

Most constraining variable

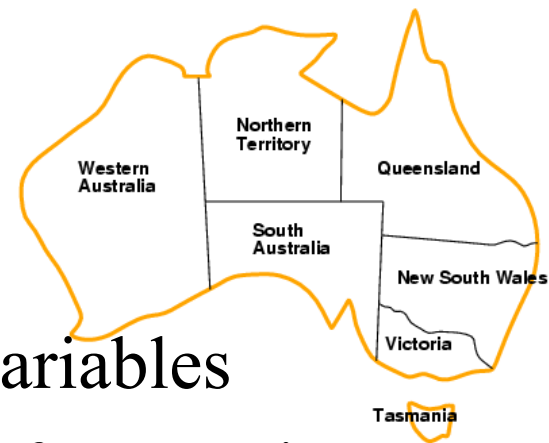

- Tie-breaker among most constrained variables
- Choose variable involved in largest # of constraints on remaining variables

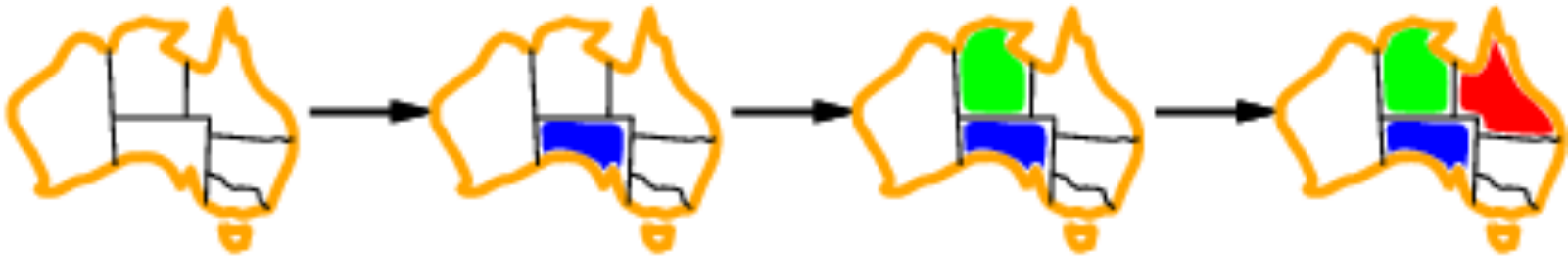

- After assigning SA to be blue, WA, NT, Q, NSW and V all have just two values left.
- WA and V have only one constraint on remaining variables and T none, so choose one of NT, Q & NSW

Least constraining value

- Given a variable, choose least constraining value:
 - the one that rules out the fewest values in the remaining variables

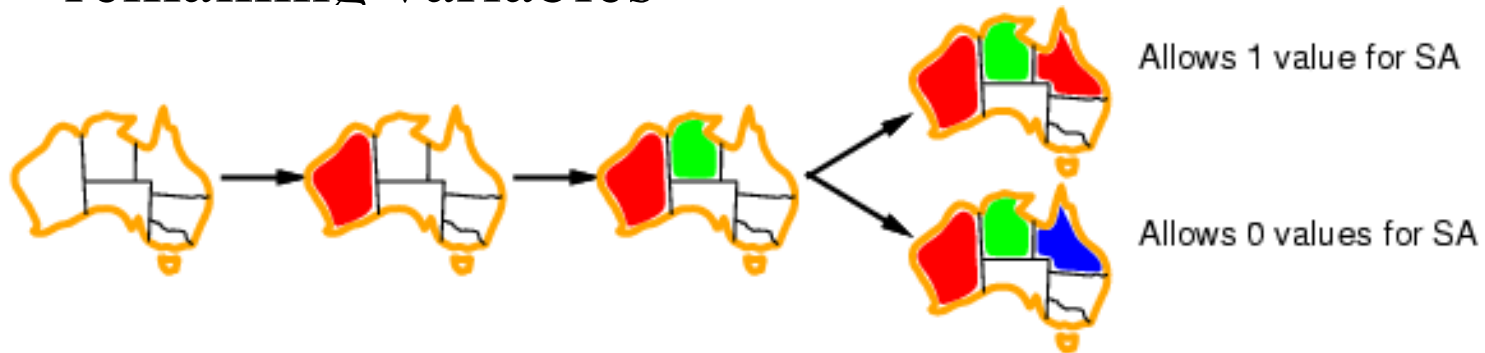

- Combining these heuristics makes 1000 queens feasible
- What's an intuitive explanation for this?

Is AC3 Alone Sufficient?

Consider the four queens problem

	1	2	3	4
1				
2				
3				
4				

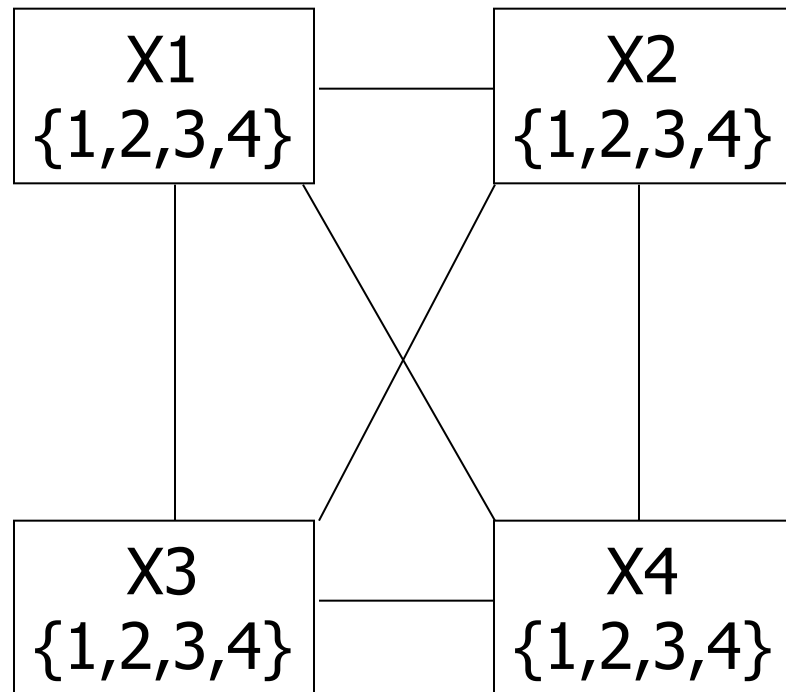

Solving a CSP still requires search

- Search:
 - can find good solutions, but must examine non-solutions along the way
- Constraint Propagation:
 - can rule out non-solutions, but this is not the same as finding solutions
- Interweave constraint propagation & search:
 - Perform constraint propagation at each search step

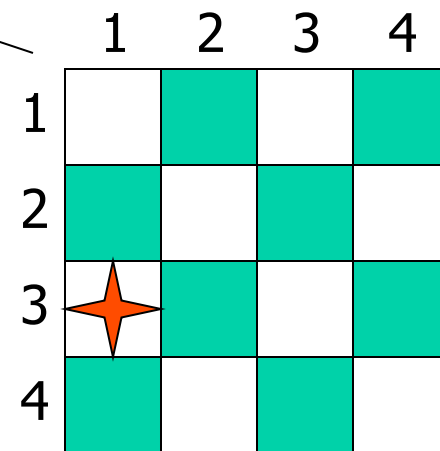
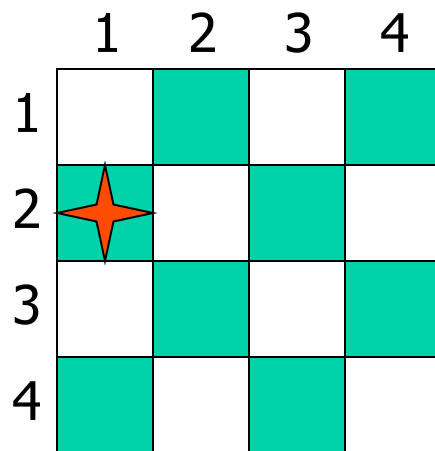
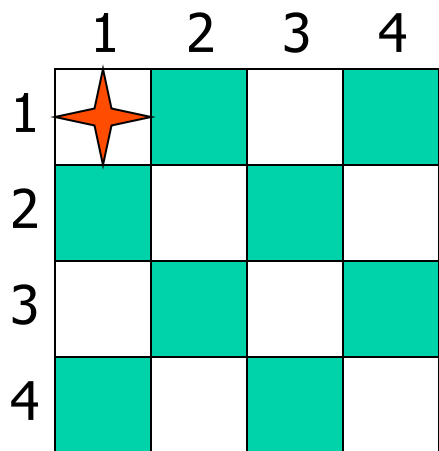
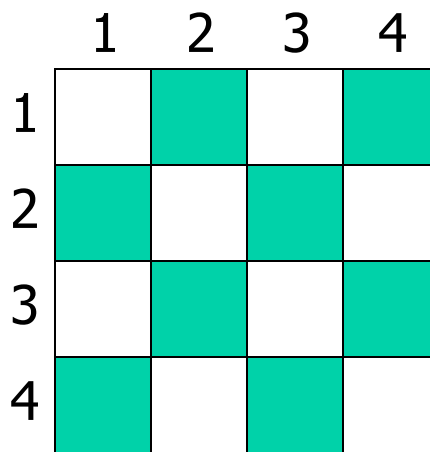

4-Queens Problem

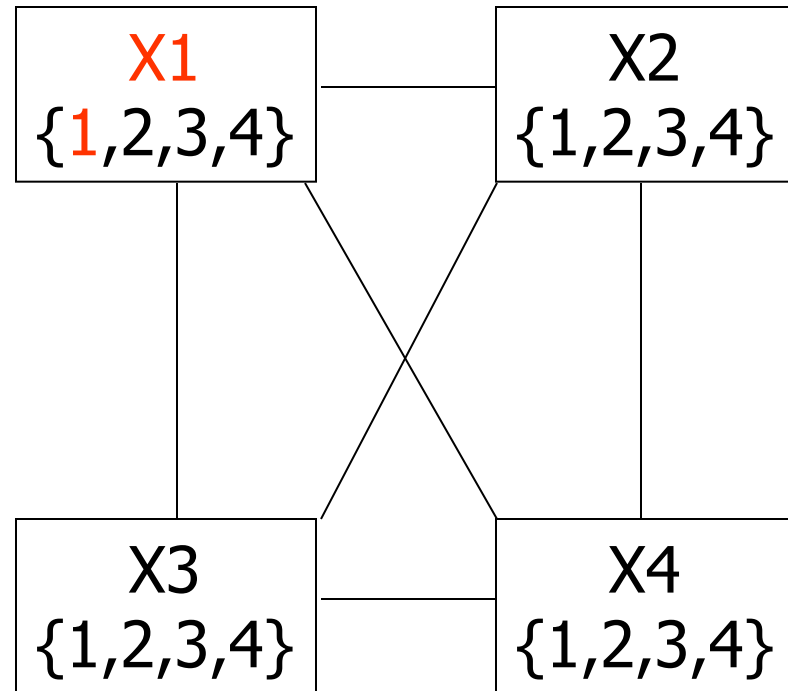
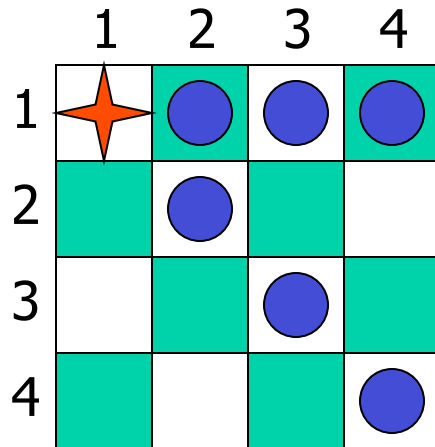

4-Queens Problem

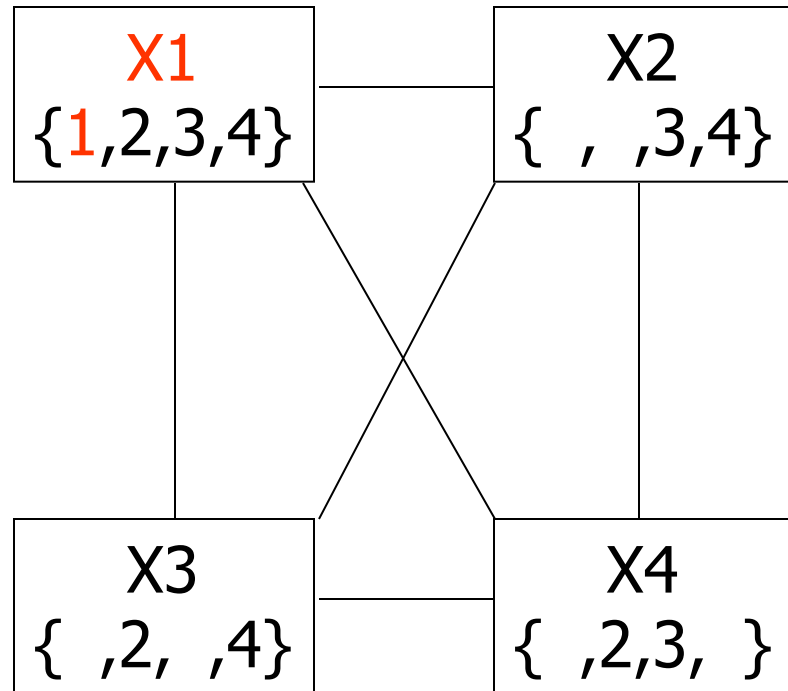
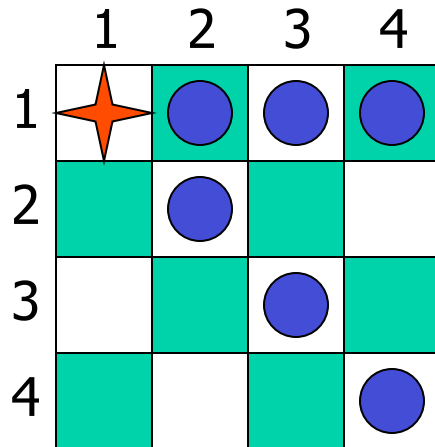

4-Queens Problem

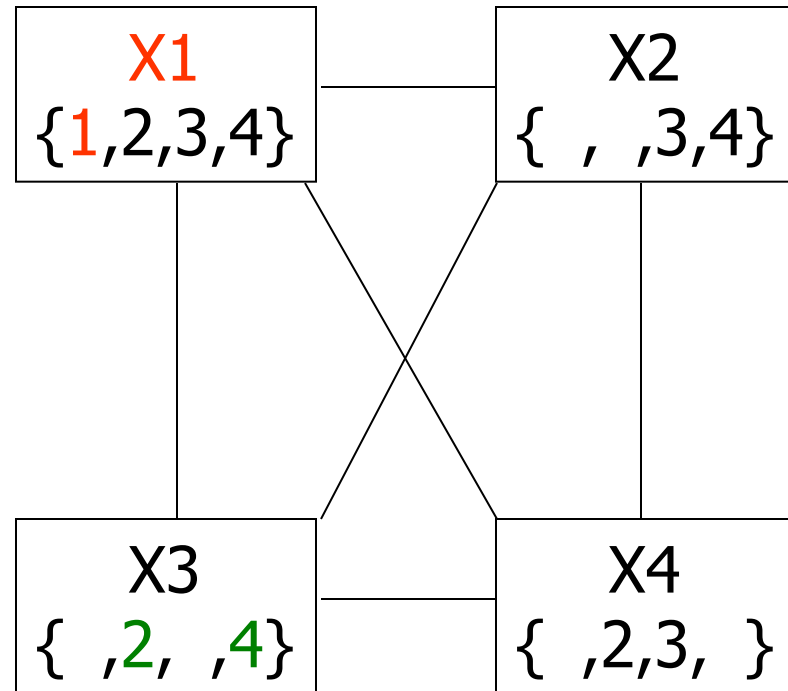
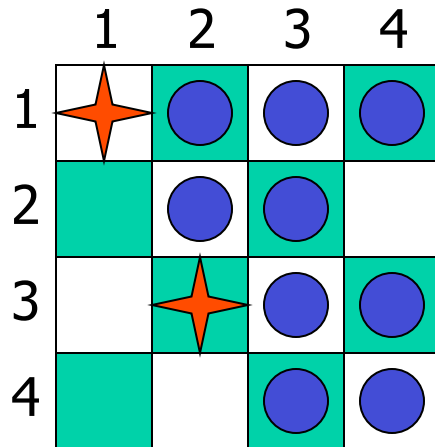

**X2=3 eliminates { X3=2, X3=3, X3=4 }
⇒ inconsistent!**

4-Queens Problem

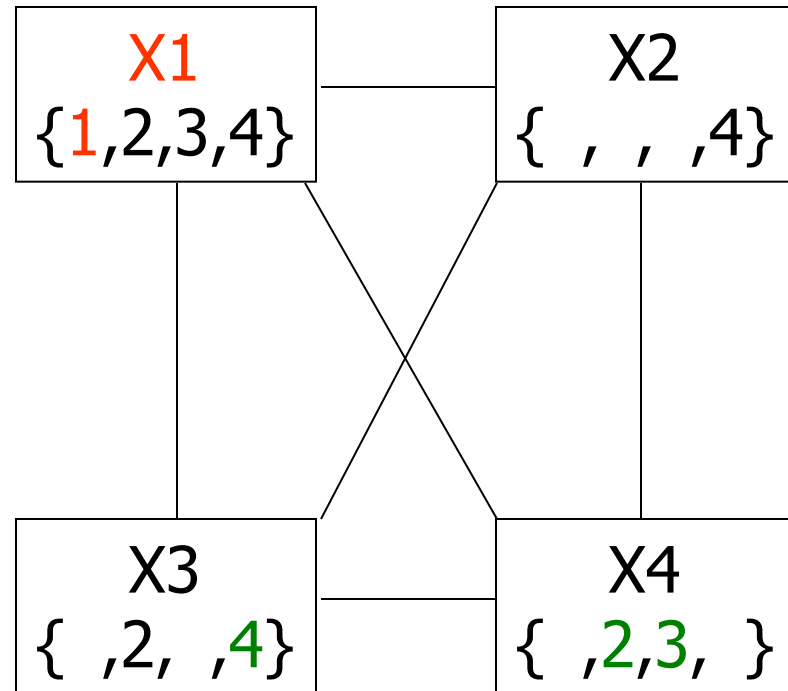
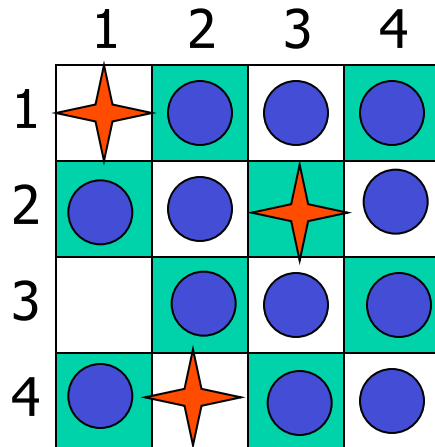

**$X2=4 \Rightarrow X3=2$, which eliminates $\{ X4=2, X4=3 \}$
 \Rightarrow inconsistent!**

4-Queens Problem

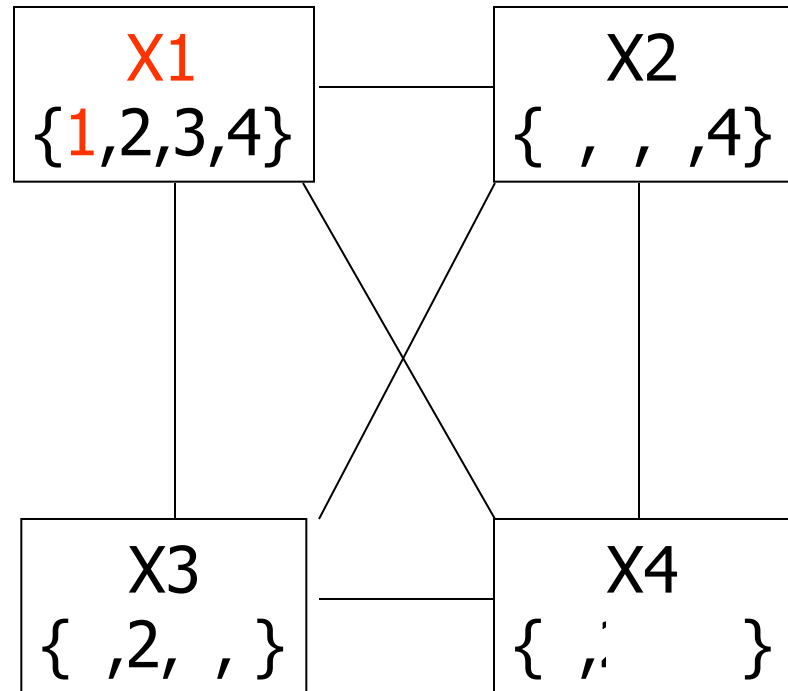
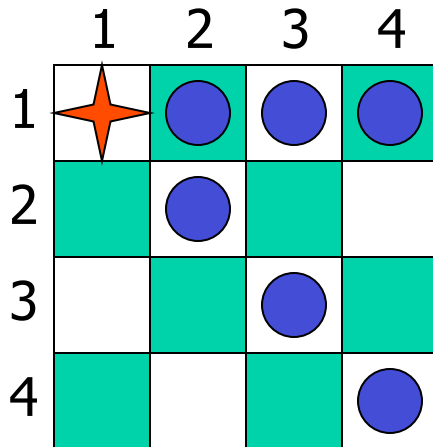

**X3=2 eliminates { X4=2, X4=3 }
⇒ inconsistent!**

4-Queens Problem

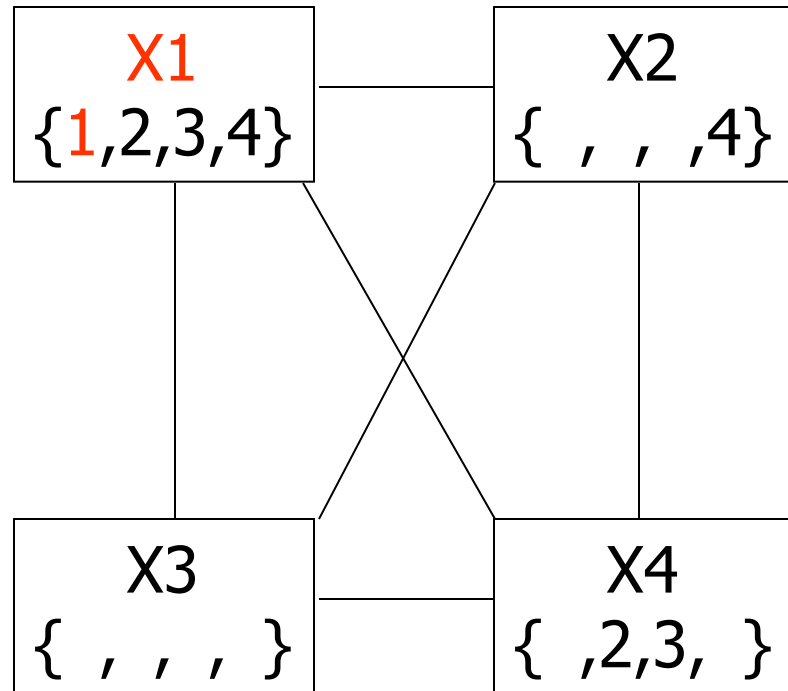
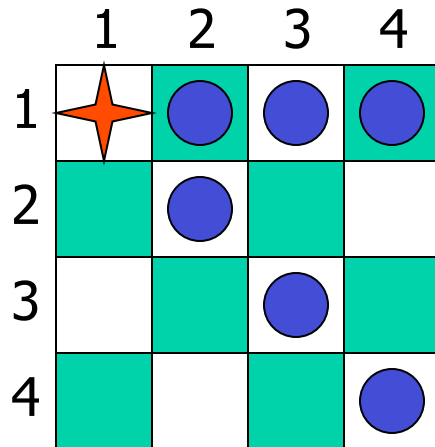

4-Queens Problem

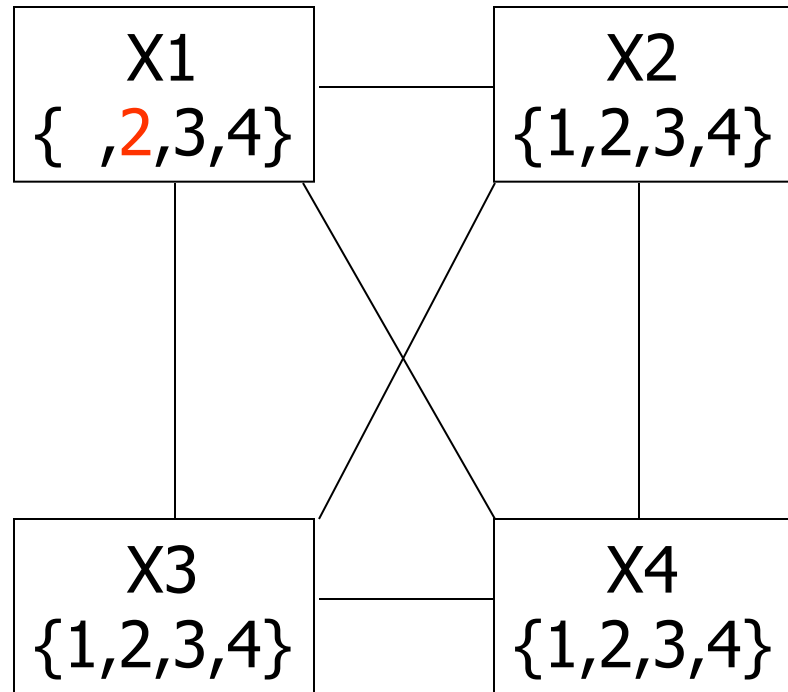
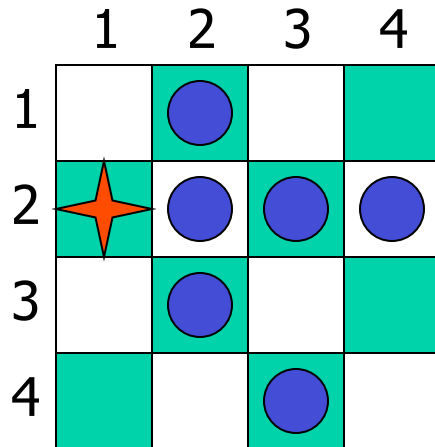

4-Queens Problem

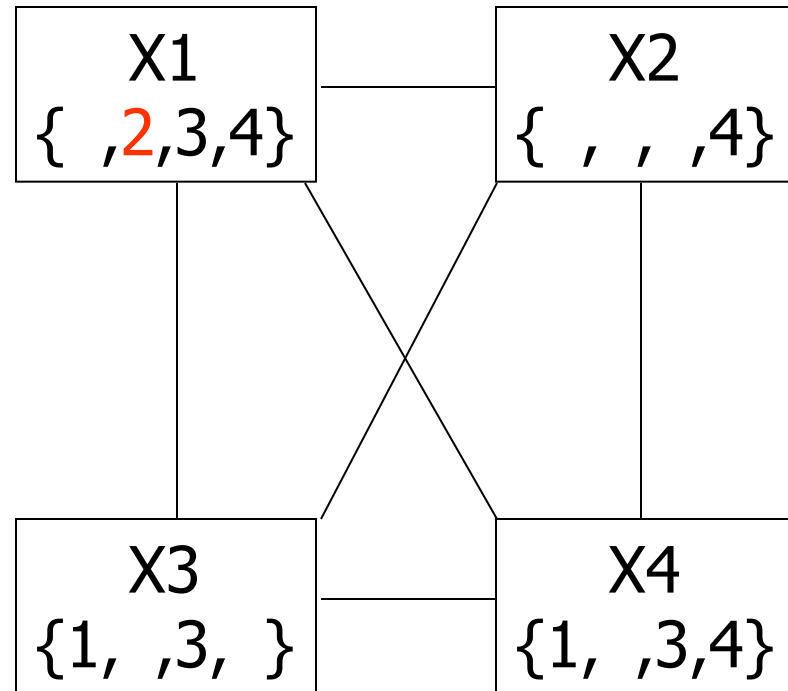
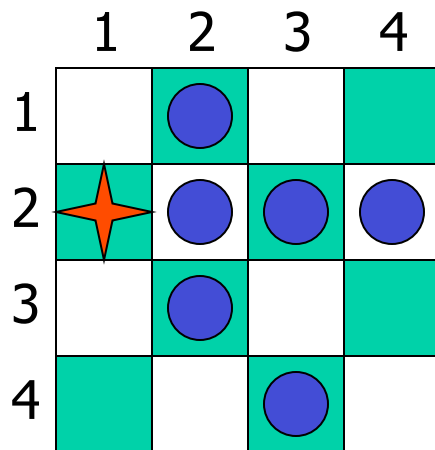

Can we eliminate any other values?

4-Queens Problem

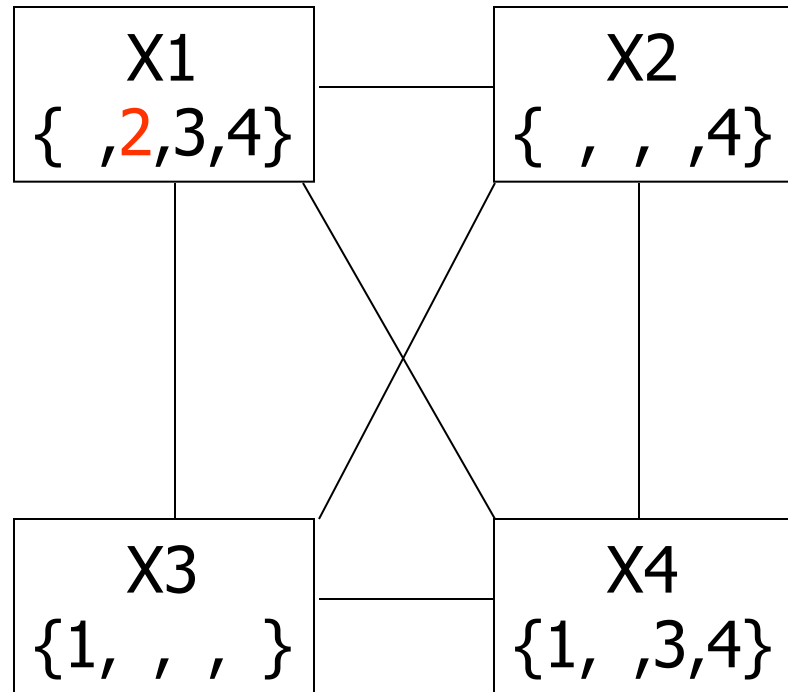
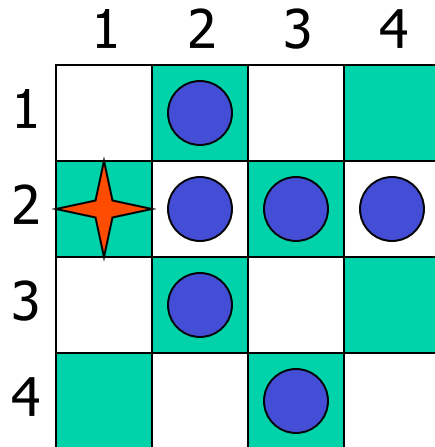

4-Queens Problem

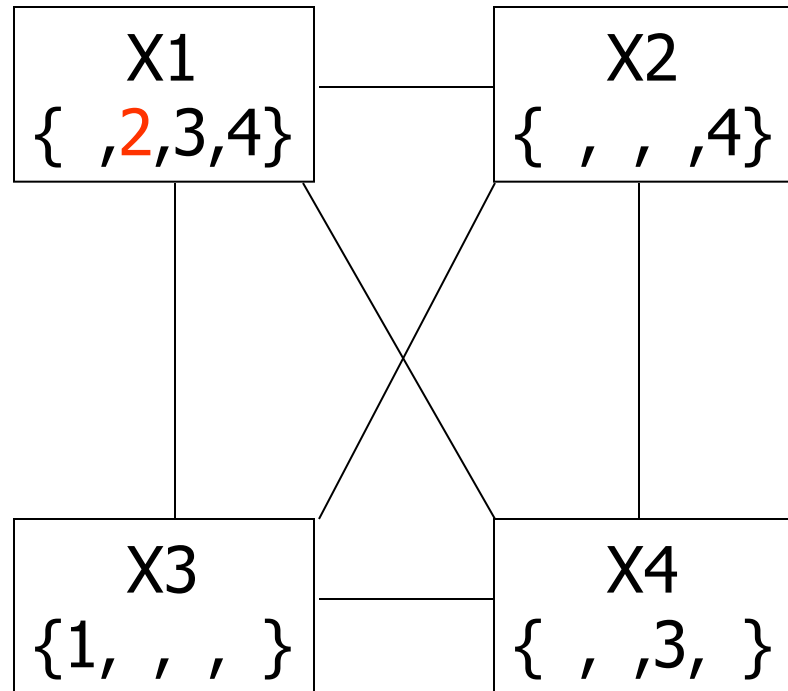
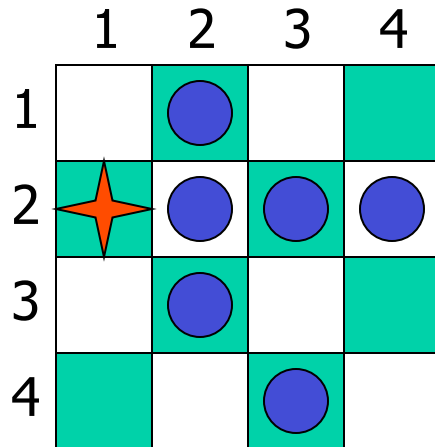

4-Queens Problem

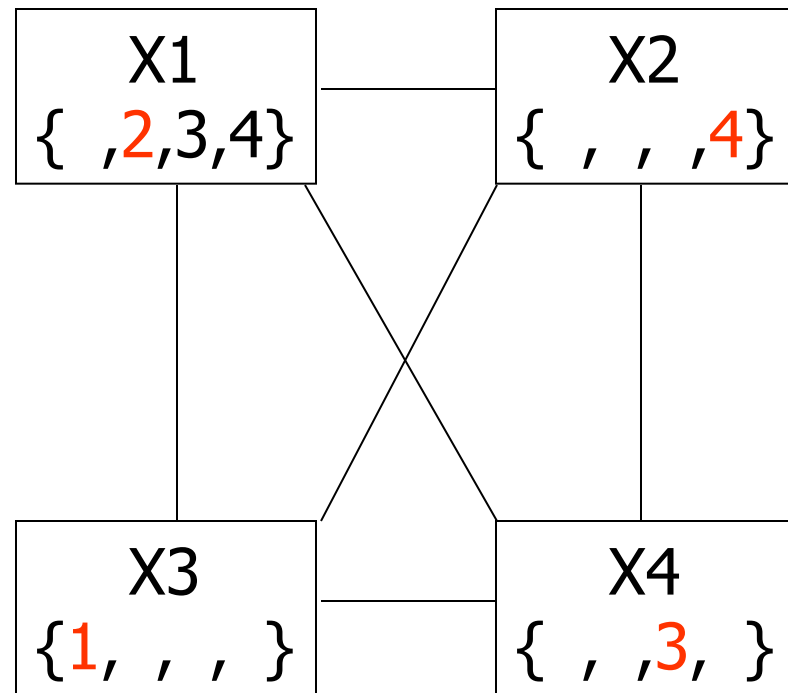
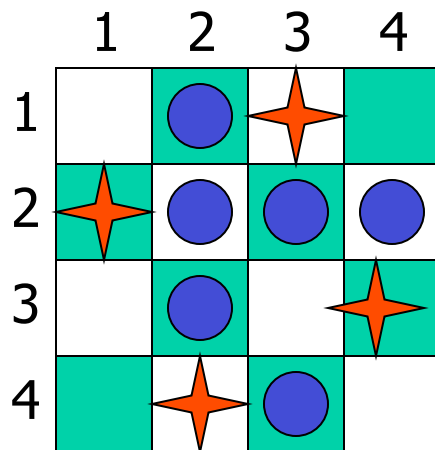

Sudoku Example

	1	2	3	4	5	6	7	8	9
A			3		2		6		
B	9			3		5			1
C			1	8		6	4		
D			8	1		2	9		
E	7								8
F			6	7		8	2		
G			2	6		9	5		
H	8			2		3			9
I			5		1		3		

	1	2	3	4	5	6	7	8	9
A	4	8	3	9	2	1	6	5	7
B	9	6	7	3	4	5	8	2	1
C	2	5	1	8	7	6	4	9	3
D	5	4	8	1	3	2	9	7	6
E	7	2	9	5	6	4	1	3	8
F	1	3	6	7	9	8	2	4	5
G	3	7	2	6	8	9	5	1	4
H	8	1	4	2	5	3	7	6	9
I	6	9	5	4	1	7	3	8	2

How can we set this up as a CSP?

Sudoku

- Digit placement puzzle on 9x9 grid with unique answer
- Given an initial partially filled grid, fill remaining squares with a digit between 1 and 9
- Each column, row, and nine 3×3 sub-grids must contain all nine digits

	1	2	3	4	5	6	7	8	9
A			3		2		6		
B	9			3		5			1
C			1	8		6	4		
D			8	1		2	9		
E	7								8
F			6	7		8	2		
G			2	6		9	5		
H	8			2		3			9
I			5		1		3		

	1	2	3	4	5	6	7	8	9
A	4	8	3	9	2	1	6	5	7
B	9	6	7	3	4	5	8	2	1
C	2	5	1	8	7	6	4	9	3
D	5	4	8	1	3	2	9	7	6
E	7	2	9	5	6	4	1	3	8
F	1	3	6	7	9	8	2	4	5
G	3	7	2	6	8	9	5	1	4
H	8	1	4	2	5	3	7	6	9
I	6	9	5	4	1	7	3	8	2

- Some initial configurations are easy to solve and some very difficult

```

def sudoku(initValue):
    p = Problem()
    # Define a variable for each cell: 11,12,13...21,22,23...98,99
    for i in range(1, 10) :
        p.addVariables(range(i*10+1, i*10+10), range(1, 10))
    # Each row has different values
    for i in range(1, 10) :
        p.addConstraint(AllDifferentConstraint(), range(i*10+1, i*10+10))
    # Each colum has different values
    for i in range(1, 10) :
        p.addConstraint(AllDifferentConstraint(), range(10+i, 100+i, 10))
    # Each 3x3 box has different values
    p.addConstraint(AllDifferentConstraint(), [11,12,13,21,22,23,31,32,33])
    p.addConstraint(AllDifferentConstraint(), [41,42,43,51,52,53,61,62,63])
    p.addConstraint(AllDifferentConstraint(), [71,72,73,81,82,83,91,92,93])

    p.addConstraint(AllDifferentConstraint(), [14,15,16,24,25,26,34,35,36])
    p.addConstraint(AllDifferentConstraint(), [44,45,46,54,55,56,64,65,66])
    p.addConstraint(AllDifferentConstraint(), [74,75,76,84,85,86,94,95,96])

    p.addConstraint(AllDifferentConstraint(), [17,18,19,27,28,29,37,38,39])
    p.addConstraint(AllDifferentConstraint(), [47,48,49,57,58,59,67,68,69])
    p.addConstraint(AllDifferentConstraint(), [77,78,79,87,88,89,97,98,99])

    # add unary constraints for cells with initial non-zero values
    for i in range(1, 10) :
        for j in range(1, 10):
            value = initValue[i-1][j-1]
            if value:
                p.addConstraint(lambda var, val=value: var == val, (i*10+j,))
    return p.getSolution()

```

```

# Sample problems
easy = [
    [0,9,0,7,0,0,8,6,0],
    [0,3,1,0,0,5,0,2,0],
    [8,0,6,0,0,0,0,0,0],
    [0,0,7,0,5,0,0,0,6],
    [0,0,0,3,0,7,0,0,0],
    [5,0,0,0,1,0,7,0,0],
    [0,0,0,0,0,0,1,0,9],
    [0,2,0,6,0,0,0,5,0],
    [0,5,4,0,0,8,0,7,0]]

hard = [
    [0,0,3,0,0,0,4,0,0],
    [0,0,0,0,7,0,0,0,0],
    [5,0,0,4,0,6,0,0,2],
    [0,0,4,0,0,0,8,0,0],
    [0,9,0,0,3,0,0,2,0],
    [0,0,7,0,0,0,5,0,0],
    [6,0,0,5,0,2,0,0,1],
    [0,0,0,0,9,0,0,0,0],
    [0,0,9,0,0,0,3,0,0]]

very_hard = [
    [0,0,0,0,0,0,0,0,0],
    [0,0,9,0,6,0,3,0,0],
    [0,7,0,3,0,4,0,9,0],
    [0,0,7,2,0,8,6,0,0],
    [0,4,0,0,0,0,0,7,0],
    [0,0,2,1,0,6,5,0,0],
    [0,1,0,9,0,5,0,4,0],
    [0,0,8,0,2,0,7,0,0],
    [0,0,0,0,0,0,0,0,0]]

```

Local search for constraint problems

- Remember local search?
- A version of local search exists for constraint problems
- Basic idea:
 - generate a random “solution”
 - Use metric of “number of conflicts”
 - Modifying solution by reassigning one variable at a time to decrease metric until a solution is found or no modification improves it
- Has all the features and problems of local search

Min Conflict Example

- **States:** 4 Queens, 1 per column
- **Operators:** Move queen in its column
- **Goal test:** No attacks
- **Evaluation metric:** Total number of attacks

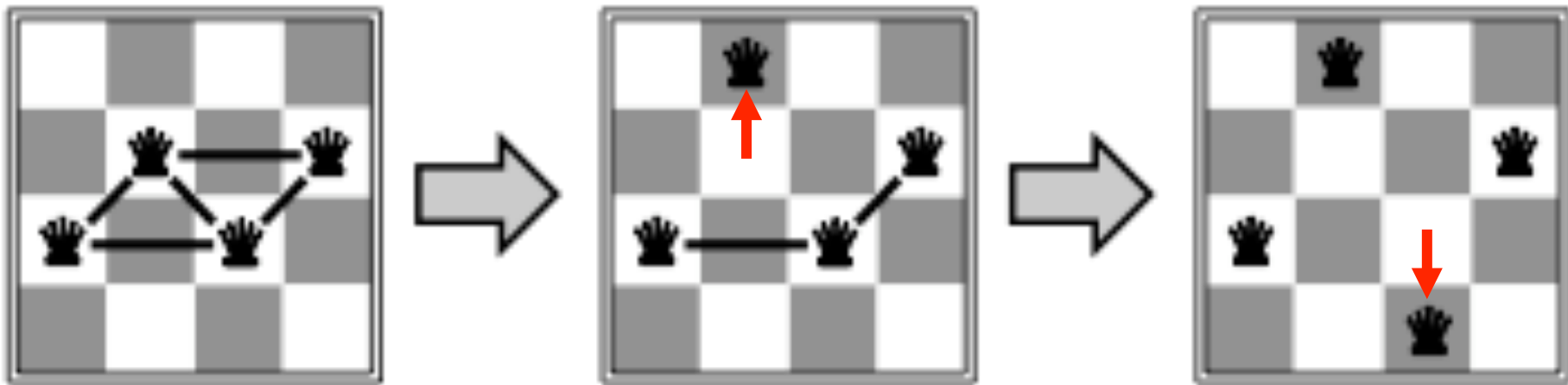

How many conflicts does each state have?

Basic Local Search Algorithm

Assign a domain value d_i to each variable v_i
while no solution & not stuck & not timed out:

bestCost $\leftarrow \infty$; bestList $\leftarrow \emptyset$;

for each variable $v_i \mid \text{Cost}(\text{Value}(v_i)) > 0$

for each domain value d_i of v_i

if $\text{Cost}(d_i) < \text{bestCost}$

bestCost $\leftarrow \text{Cost}(d_i)$; bestList $\leftarrow d_i$;

else if $\text{Cost}(d_i) = \text{bestCost}$

bestList $\leftarrow \text{bestList} \cup d_i$

Take a randomly selected move from bestList

Eight Queens using Backtracking

Undo move
for Queen 7
and so on...

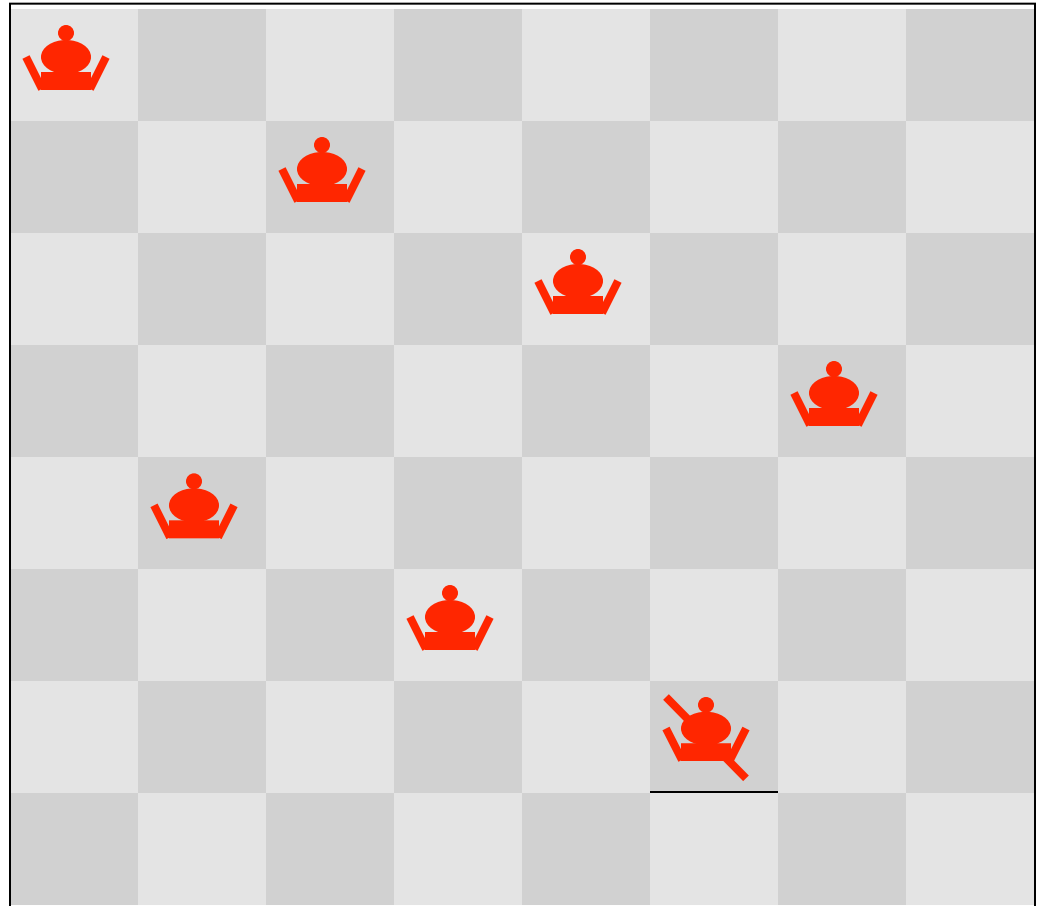

Eight Queens using Local Search

Answer Found

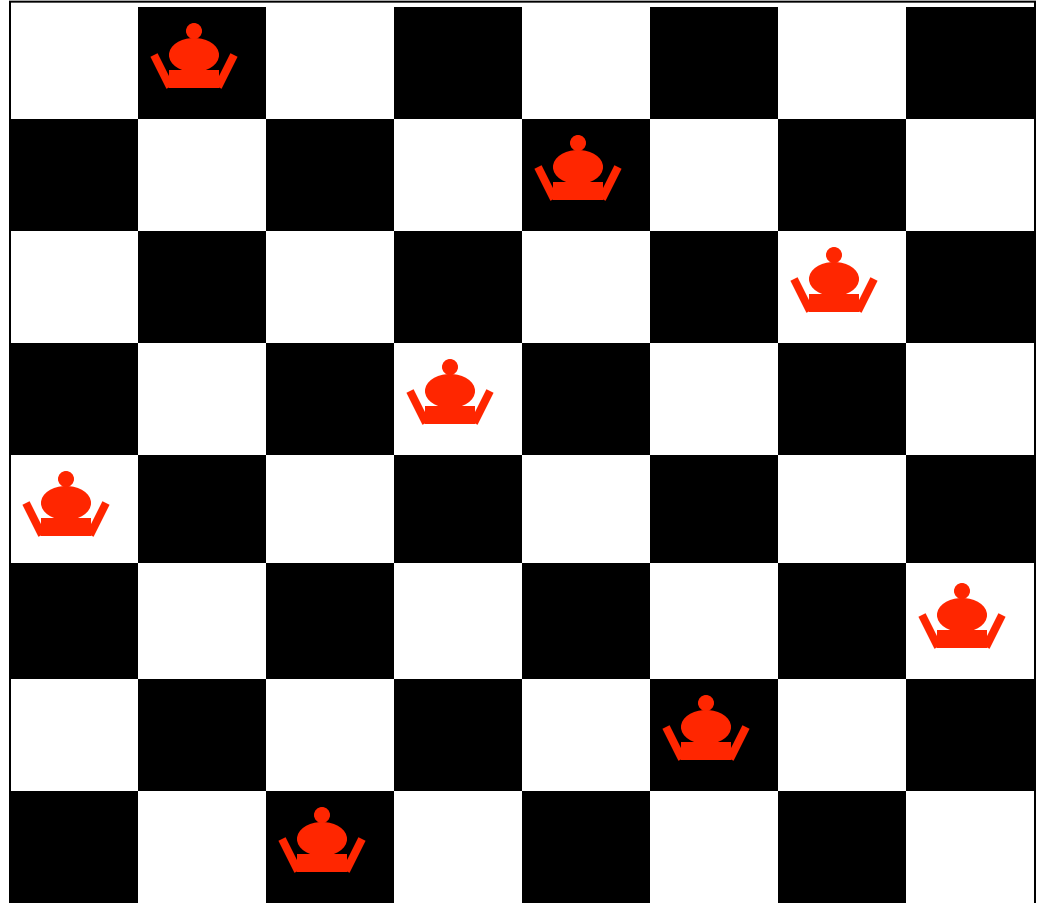

Backtracking Performance

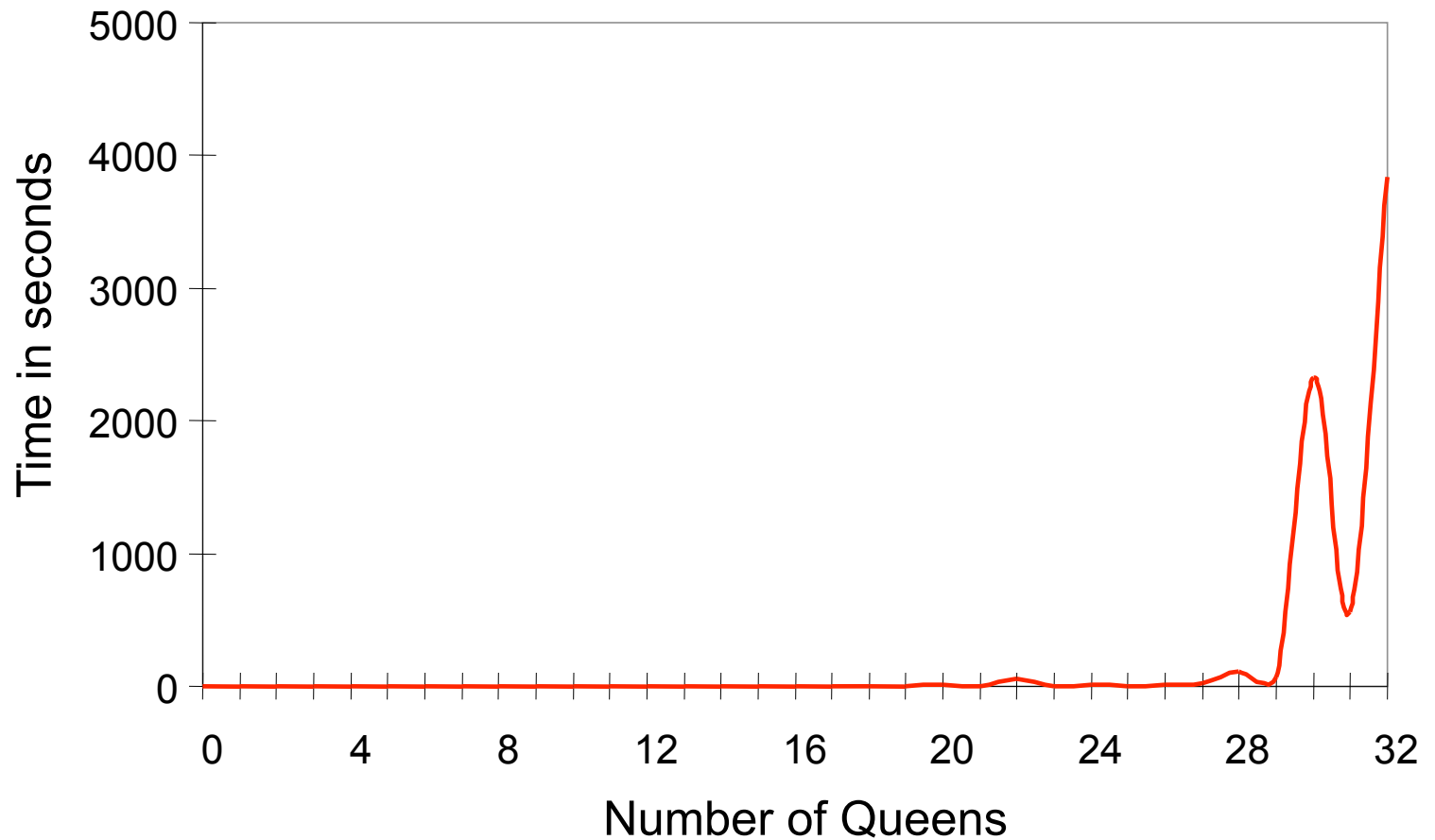

Local Search Performance

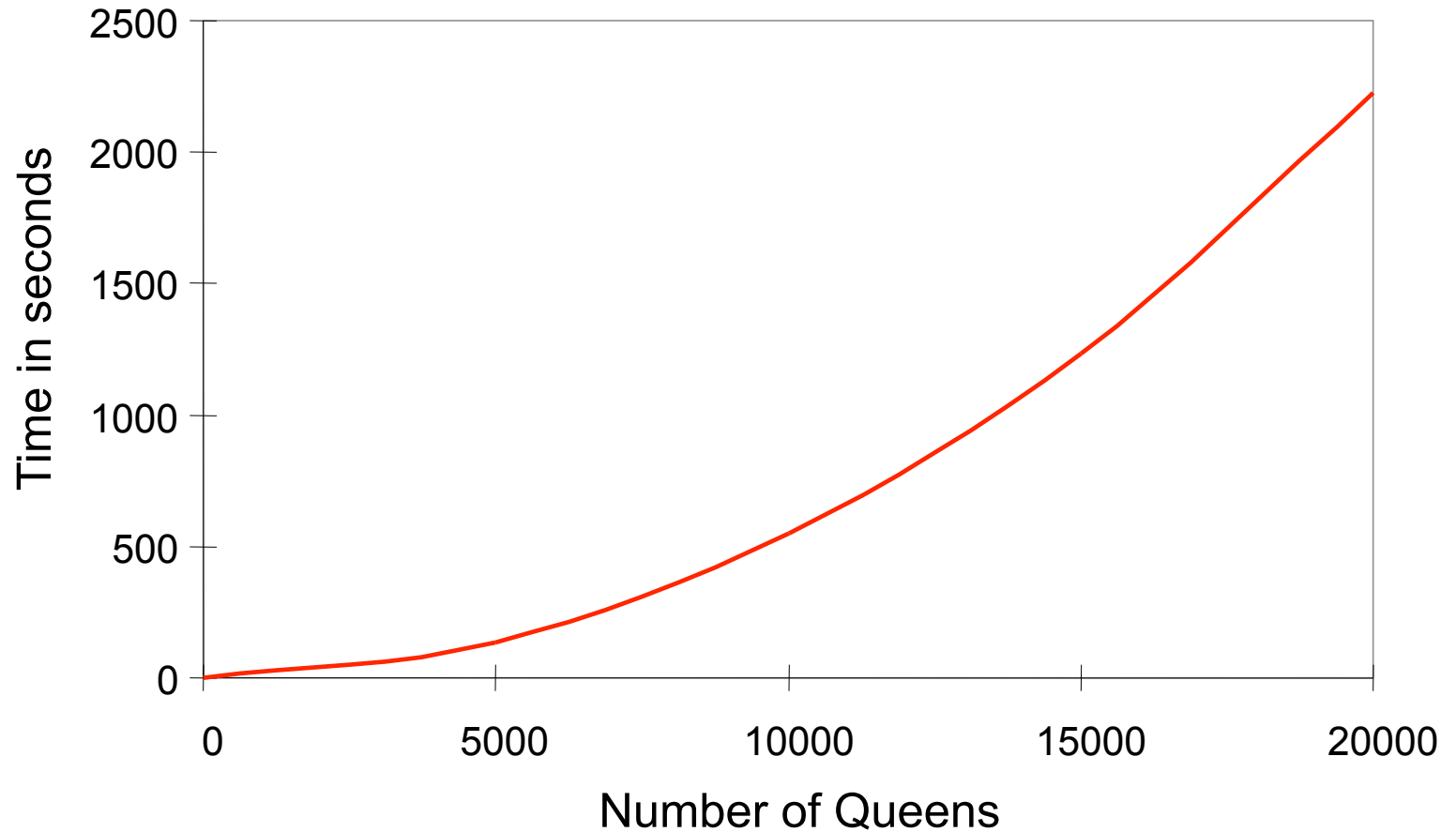

Min Conflict Performance

- Performance depends on quality and informativeness of initial assignment; inversely related to distance to solution
- Min Conflict often has astounding performance
- For example, it's been shown to solve arbitrary size (in the millions) N-Queens problems in constant time.
- This appears to hold for arbitrary CSPs with the caveat...

Min Conflict Performance

Except in a certain critical range of the ratio constraints to variables.

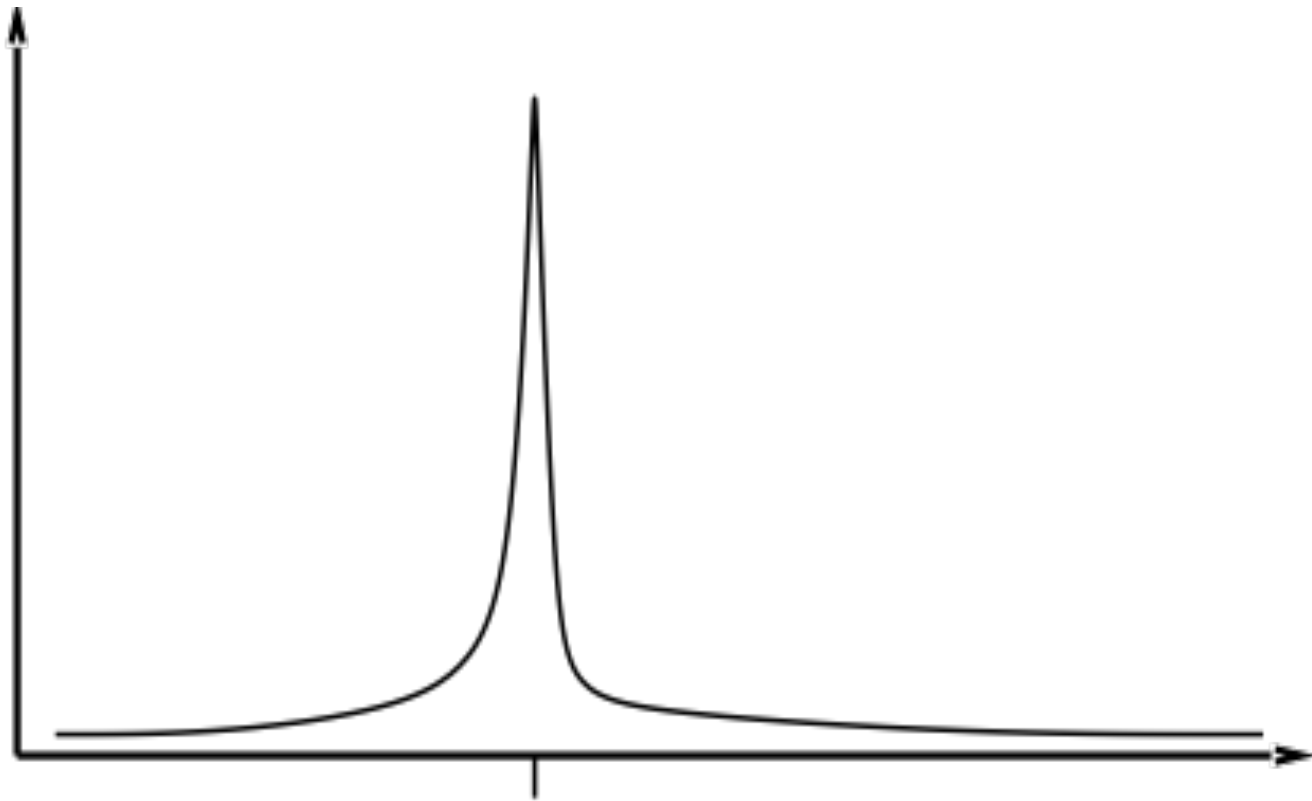

Famous example: labeling line drawings

- Waltz labeling algorithm – earliest AI CSP application
 - Convex interior lines are labeled as +
 - Concave interior lines are labeled as –
 - Boundary lines are labeled as
- There are 208 labeling (most of which are impossible)
- Here are the 18 legal labeling:

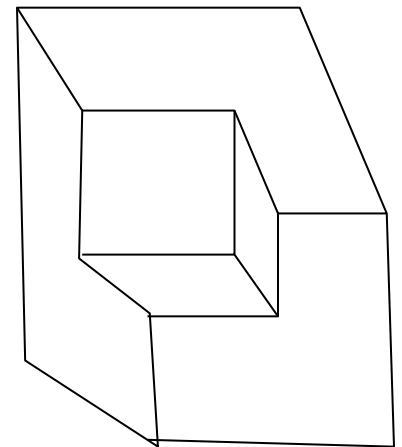
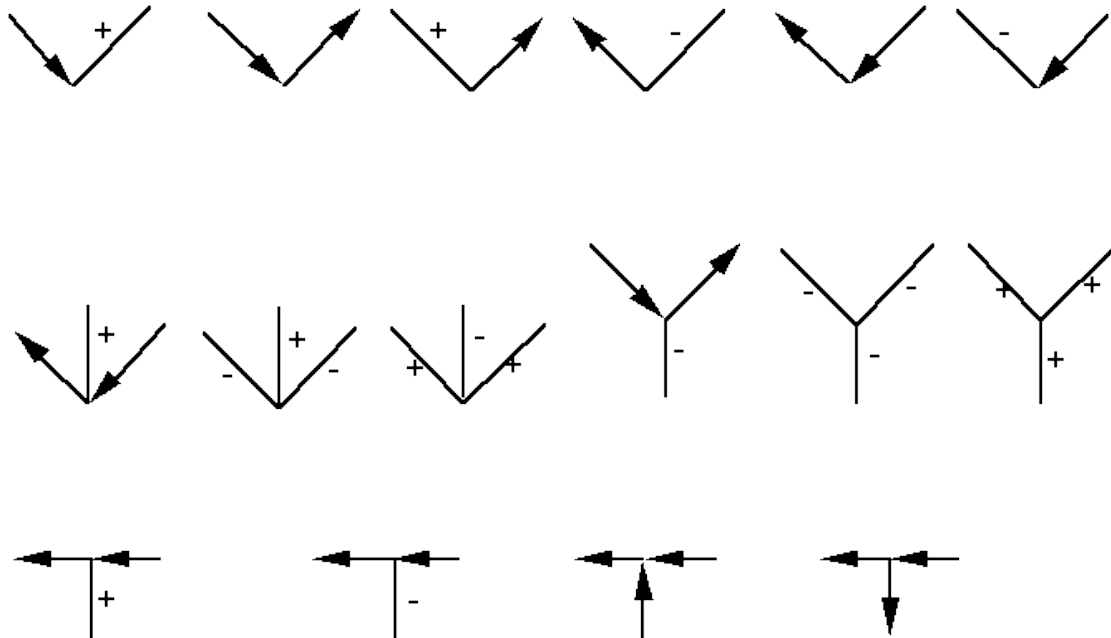

Labeling line drawings II

- Here are some illegal labelings:

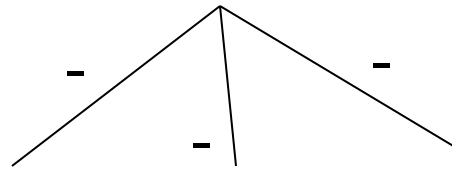
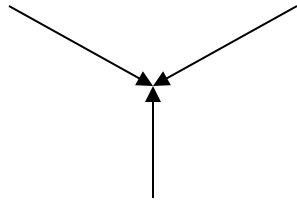
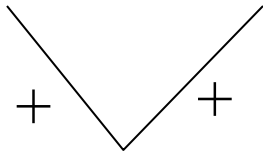

Labeling line drawings

Waltz labeling algorithm: propagate constraints repeatedly until a solution is found

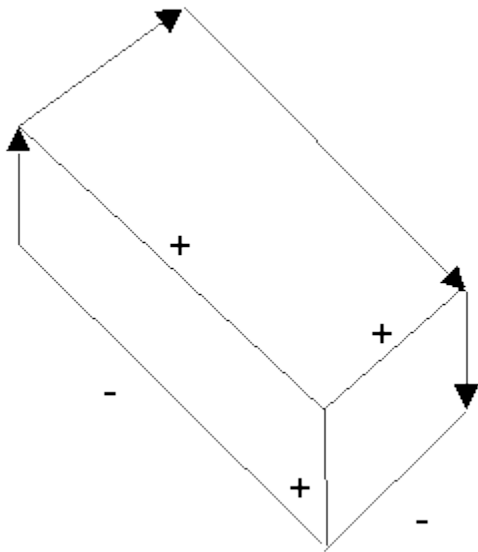

A solution for one labeling problem

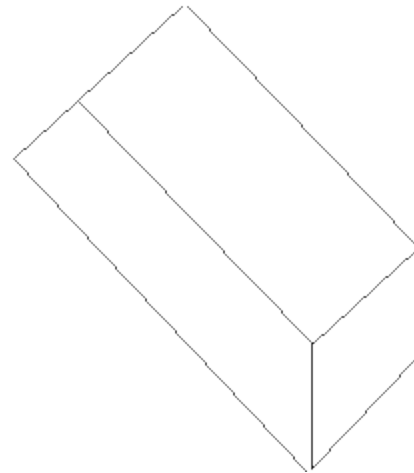

A labeling problem with no solution

Shadows add complexity

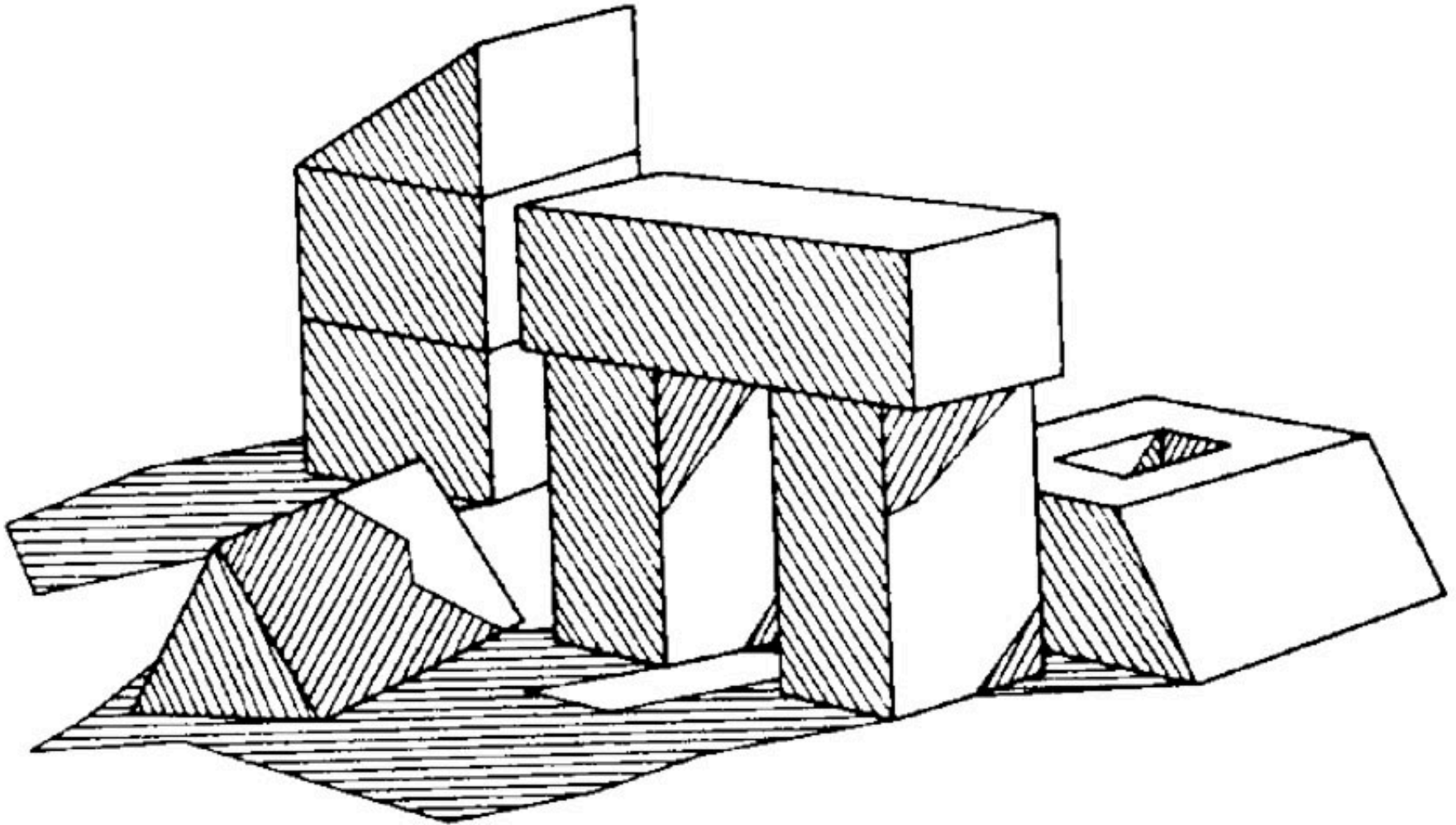

CSP was able to label scenes where some of the lines were caused by shadows

K-consistency

- K-consistency generalizes arc consistency to sets of more than two variables.
 - A graph is K-consistent if, for legal values of any K-1 variables in the graph, and for any Kth variable V_k , there is a legal value for V_k
- Strong K-consistency = J-consistency for all $J \leq K$
- **Node consistency = strong 1-consistency**
- **Arc consistency = strong 2-consistency**
- **Path consistency = strong 3-consistency**

Why do we care?

1. If we have a CSP with N variables that is known to be **strongly N -consistent**, we can solve it **without backtracking**
2. For any CSP that is **strongly K -consistent**, if we find an **appropriate variable ordering** (one with “small enough” branching factor), we can solve the CSP **without backtracking**

Intelligent backtracking

- **Backjumping**: if V_j fails, jump back to the variable V_i with greatest i such that the constraint (V_i, V_j) fails (i.e., most recently instantiated variable in conflict with V_i)
- **Backchecking**: keep track of incompatible value assignments computed during backjumping
- **Backmarking**: keep track of which variables led to the incompatible variable assignments for improved backchecking

Challenges for constraint reasoning

- What if not all constraints can be satisfied?
 - Hard vs. soft constraints
 - Degree of constraint satisfaction
 - Cost of violating constraints
- What if constraints are of different forms?
 - Symbolic constraints
 - Numerical constraints [constraint solving]
 - Temporal constraints
 - Mixed constraints

Challenges for constraint reasoning

- What if constraints are represented intensionally?
 - Cost of evaluating constraints (time, memory, resources)
- What if constraints, variables, and/or values change over time?
 - Dynamic constraint networks
 - Temporal constraint networks
 - Constraint repair
- What if multiple agents or systems are involved in constraint satisfaction?
 - Distributed CSPs
 - Localization techniques